

LEGEND

	4-year warranty		Non-Anodized
	Restriction of Hazardous Substance		Silver Anodized
	Recessed		Black Anodized
	Bendable		White
	Closet-Rated		Focusing Lens with 100% light transmission
	IP22		Universal Clear Pro with 91% light transmission
	Static White		Universal Frosted Pro with 80% light transmission
	High Density		Universal Clear with 85% light transmission
	Full Spectrum		Universal Frosted with 70% light transmission
	Side Emitting		Extreme Clear with 89% light transmission
	Ultra Slim		Extreme Frosted with 70% light transmission
	Dim to Warm		In-Ground Frosted with 58% light transmission
	Tunable White		Ultra Slim Frosted with 70% light transmission

*Most Xicato Channels are IP65 ready with proper sealant applied around the end caps to completely seal the XFL inside the channel.

Xicato designs and delivers one of the broadest portfolio spot and linear light sources and electronics that enable architects, designers and building managers to create beautiful, smart spaces in which people love to live and work. With thousands of installations around the globe, Xicato continues to be a leading supplier of high quality lighting solutions. Xicato is defining the future of intelligent light sources by integrating electronics, software and connectivity. Founded in 2007, Xicato has offices in China, Europe and the U.S., with it's headquarters based in Silicon Valley.



See legend on first page

Product Description

- Small 12mm height that offers flexibility for those hard to light applications.
- Easily embedded in narrow grooves or for backlighting luminaires.
- Simple assembly
- Environmentally friendly
- Good heat dissipation
- Designed to reach an IP67 waterproof rating

Finish

Non anodized (raw)	NA	Black anodized	BK
Silver anodized	SA	White	WT

XCC-L Lenses*

TL BK	PRO CL	PRO FR	UNV CL	UNV FR	EX CL	EX FR
33%	91%	80%	85%	70%	89%	70%

- XCC-L-TL-BK
- XCC-L-PRO-CL
- XCC-L-PRO-FR
- XCC-L-UNV-CL
- XCC-L-UNV-FR
- XCC-L-EX-CL
- XCC-L-EX-FR

XCC-E End Caps*

- XCC-E-S12-NA-EC-STD
- XCC-E-S12-NA-NC-STD
- XCC-E-S12-NA-NC-HOLE
- XCC-E-S12-BK-NC-STD
- XCC-E-S12-SA-NC-STD

XCC-M Mountings*

- XCC-M-TYPA-BK-H
- XCC-M-TYPA-WT-H
- XCC-M-TYPA-NA-H
- XCC-M-SLM-NA-V
- XCC-M-ADJ-NA-A

Internal Dimensions

Height: 10mm
Width for LED: 11.2mm

Product Image



Technical Drawing

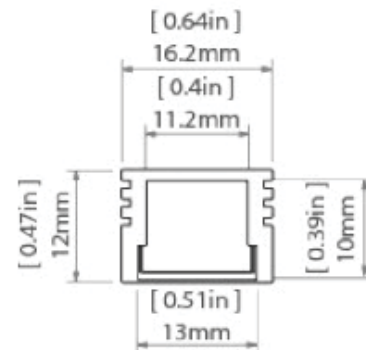

As Installed

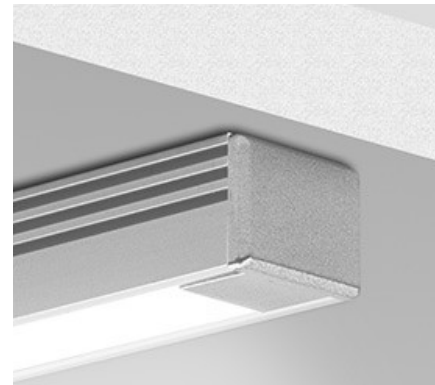

*For more detailed information please see Compatible Accessories guide

Compatible XFL Products



SKU Information

Product	Collection	Name Code	Surface Code	Length
XCC	C	DS12	SA	1
			BK	2
				3
				WT
			NA	1
				2

Technical Specification

Application:

- Designed for the construction of lighting fixtures and back lighting luminaries
- In furniture, exhibition, interior design elements like stair treads, platforms, shelves, niches, etc.
- Can be embedded in narrow grooves
- Can be used for external illumination in the sealed version, except for applications where it would be exposed to considerable mechanical forces

Mounting:

- Can be mounted with appropriately selected mounting adhesives, professional double-side adhesive tapes, metal and plastic mounting brackets, as well as adjustable mounting brackets
- Can also be mounted to drywall panels with the use of PDS mounting spring

Additional information:

- Suitable for bending in the plane adjacent to the LED strip
- Can be equipped with transparent and frosted covers, aluminum-colored plastic, metalized and conductive end caps
- Can be made waterproof (IP67) and be used as an outdoor lighting for elevations or architectural elements of gardens
- Illumination of certain areas (stream of light may vary depending on the power of applied LEDs)
- Extrusion acts as the connector between the light source and the application area and provides a stylish and finished look
- Space for LED strip: 0.40" / 11.2 mm

Extrusion Bending

Minimum Internal Radius	Minimum External Radius
150mm / 5.9"	250mm / 9.8"

- Minimum radius – bending radius which when exceeded causes destruction (deformation, bending or lack of compatibility with other accessories, e.g. covers, end caps, etc.) of the profile
- Internal radius – refers to the extrusion bent so that the cover is facing the inside of the arch
- External radius - refers to the extrusion bent so that the cover is facing the outside of the arch
- Irregular curves are possible after consultation and individual quotation
- When bending anodized extrusions, one should be aware of cracking of the anode coating (which may be more or less visible depending on the radius)
- Possibility of making a linear fixture with IP65 protection, which means the fixture is dust proof and waterproof in contact with water jets
- Possibility of making a linear fixture with IP67 protection, which means the fixture is dust proof and waterproof

Note

Turn off LED lights during peak day light hours in outdoor applications to avoid excessive heat buildup which will result in diminished LED life.

Compatible Lenses

XCC-L-TL-BK Black Transition Lens

**TL
BK**
33%

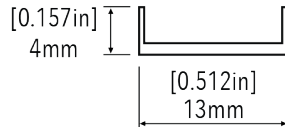
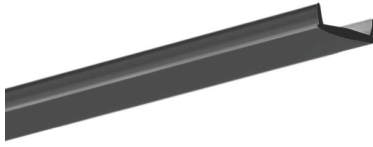

Description

Matte black surface that turns white when the light is turned on with 33% light transmission. The cover is made of UV-resistant PC measuring 13mm wide and 4mm in height. When the LEDs are off, the cover is black. The best visual effect is obtained in profiles that are black inside.

SKU				
Product	Collection	Name Code	Surface Code	Length
XCC	L	TL	BK	
				1
				2

XCC-L-PRO-CL Universal Clear - Pro

**PRO
CL**
91%

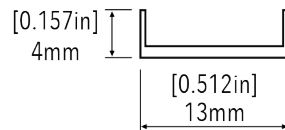

Description

Easy snap-in lens allows for simplified field installation measuring 13mm wide and 4mm in height with increased UV resistance. Transmits 91% light.

SKU				
Product	Collection	Name Code	Surface Code	Length
XCC	L	PRO	CL	
				1
				2

XCC-L-PRO-FR Universal Frosted - Pro

**PRO
FR**
80%

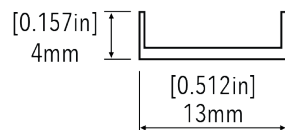

Description

Easy snap-in lens allows for simplified field installation measuring 13mm wide and 4mm in height. Increased UV resistance with 80% light transmission in the frosted version.

SKU				
Product	Collection	Name Code	Surface Code	Length
XCC	L	PRO	FR	
				1
				2

Compatible Lenses (Continued)

XCC-L-UNV-CL Universal Clear



Description

Basic 13mm wide and 4mm in height lens that is compatible with most of Xicato's channels, not UV resistant so best for indoor applications. Transmits 85% light.

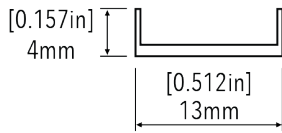

SKU				
Product	Collection	Name Code	Surface Code	Length
XCC	L	UNV	CL	1
				2

XCC-L-UNV-FR Universal Frosted



Description

Basic 13mm wide and 4mm in height lens that is compatible with most of Xicato's channels, not UV resistant so best for indoor applications. Transmits 70% light.

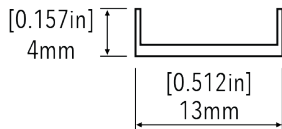

SKU				
Product	Collection	Name Code	Surface Code	Length
XCC	L	UNV	FR	1
				2

XCC-L-EX-CL Extreme Clear



Description

13mm wide and 4mm in height, these rigid covers are durable under extreme climate condition. Double-sided UV protection withstanding temperatures of up to 248°F with 89% light transmission.

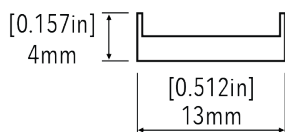

SKU				
Product	Collection	Name Code	Surface Code	Length
XCC	L	EX	CL	1
				2
				3

Compatible Lenses (Continued)

XCC-L-EX-FR
Extreme Frosted

**EX
FR**
70%

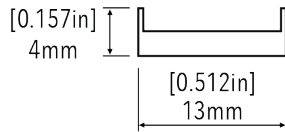

Description

13mm wide and 4mm in height, these rigid covers are durable under extreme climate condition. Double-sided UV protection withstanding temperatures of up to 248°F with 70% light transmission in the frosted version.

SKU				
Product	Collection	Name Code	Surface Code	Length
XCC	L	EX	FR	1
				2
				3

Compatible End Caps

XCC-E-S12-NA-EC-STD

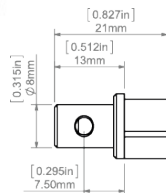

Description

Electricity conductive end caps enable regulation of light beam towards the mounting elements (such as: hanging wires).

SKU			
Product Number	Material	Color	UV Resistant
XCC-E-S12-NA-EC-STD	ABS, METAL	GRAY	NO



XCC-E-S12-NA-NC-STD



Description

Basic PP end cap in gray. High resistance to damage. Will not corrode. Simple assembly. Aesthetically finishes the extrusion.

SKU			
Product Number	Material	Color	UV Resistant
XCC-E-S12-NA-NC-STD	PP	GRAY	NO

Compatible End Caps (Continued)

XCC-E-S12-NA-NC-HOLE



Description

Basic PP end cap in gray. High resistance to damage. Will not corrode. Simple assembly. Aesthetically finishes the extrusion.

SKU			
Product Number	Material	Color	UV Resistant
XCC-E-S12-NA-NC-HOLE	PP	GRAY	NO

XCC-E-S12-BK-NC-STD



Description

Basic PP end cap in black. High resistance to damage. Will not corrode. Simple assembly. Aesthetically finishes the extrusion.

SKU			
Product Number	Material	Color	UV Resistant
XCC-E-S12-BK-NC-STD	PP	BLACK	NO

XCC-E-S12-SA-NC-STD



Description

Basic metalized PP end cap. High resistance to damage. Will not corrode. Simple assembly. Aesthetically finishes the extrusion.

SKU			
Product Number	Material	Color	UV Resistant
XCC-E-S12-SA-NC-STD	PP	METALIZED	NO

Compatible Mountings

XCC-M-TYPA-BK-H

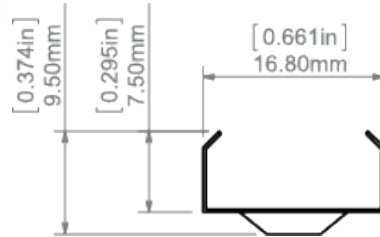

Description

A component for easy mounting of a lightweight lighting fixture to the surface. It is made of stainless steel and has a screw hole as well as flexible "wings" acting as a holder for the fixture.

SKU		
Product Number	Material	Color
XCC-M-TYPA-BK-H	STAINLESS STEEL	BLACK

XCC-M-TYPA-WT-H

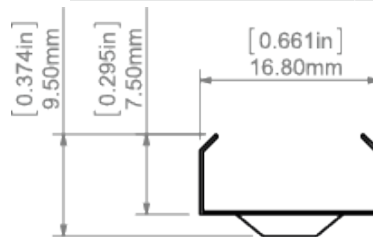

Description

A component for easy mounting of a lightweight lighting fixture to the surface. It is made of stainless steel and has a screw hole as well as flexible "wings" acting as a holder for the fixture.

SKU		
Product Number	Material	Color
XCC-M-TYPA-WT-H	STAINLESS STEEL	WHITE

XCC-M-TYPA-NA-H

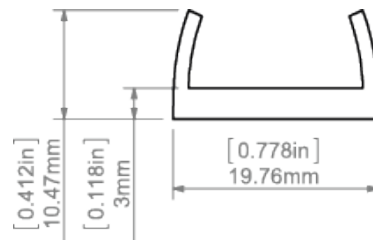

Description

A component for easy mounting of a lightweight lighting fixture to the surface. It is made of plastic and has a screw hole as well as flexible "wings" acting as a holder for the fixture. It is compatible with most standard extrusions.

SKU		
Product Number	Material	Color
XCC-M-TYPA-NA-H	ABS	GRAY

Compatible Mountings (Continued)

XCC-M-SLM-NA-V



Description

The mounting bracket is designed for embedding an extrusion in finished architectural niches. The extrusion is snapped into the mounting bracket, in a plane perpendicular to the surface. The mounting bracket has a round base that can be mounted to the surface using screws or glue that matches the mounting surface.

SKU		
Product Number	Material	Color
XCC-M-SLM-NA-V	ABS	GRAY

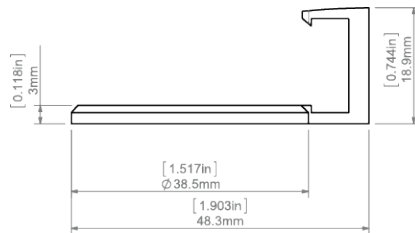

XCC-M-ADJ-NA-A



Description

A mounting bracket used for mounting extrusions to the surface which also enables light angle adjustment of the lighting fixture. It has a screw hole in the base, concealed under a removable cover. The extrusion is snapped into a movable holder

SKU		
Product Number	Material	Color
XCC-M-ADJ-NA-A	ABS	GRAY

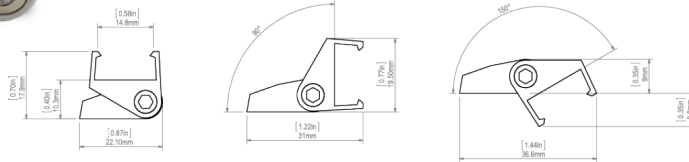

Required Parts



Mounting bracket (A)



Extrusion (B)



End cap (C)



LED strip (D)



Cover (E)

Required Tools

- Drill
- Screwdriver
- Screws

Important

- All LED strips should be connected to a 24 V power supply.
- The mounting instructions present the basic form of assembly. More methods and related accessories can be found at www.Xicato.com

Mounting Instructions

1

Feed the power cable and attach the mounting bracket (A) to the mounting surface with screws.

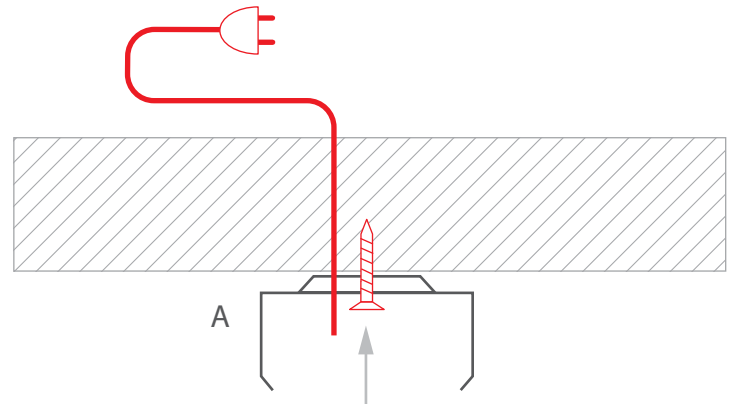

2

Mount the LED strip (D) in the extrusion (B), insert the cover (E), and the end cap (C).

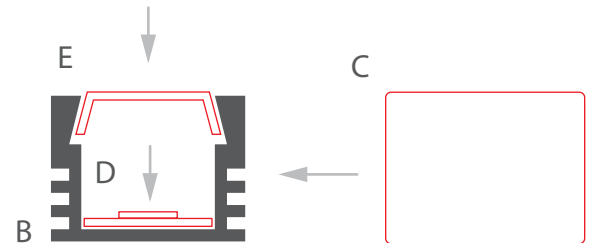

Mounting Instructions (Continued)

3

- Connect power to the LED strip and mount the extrusion (B) in the mounting bracket (A).
- There are two ways to connect power: through a hole in the extrusion or through the end cap.

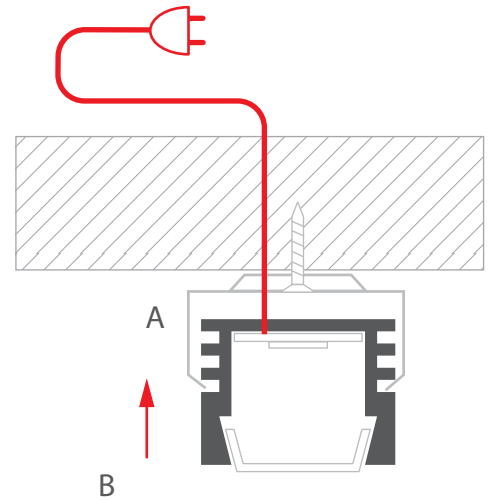



Xicato Global Headquarters

102 Cooper Court,
Los Gatos, CA 95032

Contact Us

Tel: +1 866 223 8395
info@xicato.com
www.xicato.com

For the most up-to-date data sheet, please visit xicato.com/support.

2022 Xicato, Inc. Product specifications are subject to change without notice. Xicato and the Xicato stylized logo design are registered trademarks of Xicato.